

Plan Care

34901170800 Grab bar

PRODUCT



DRAWING

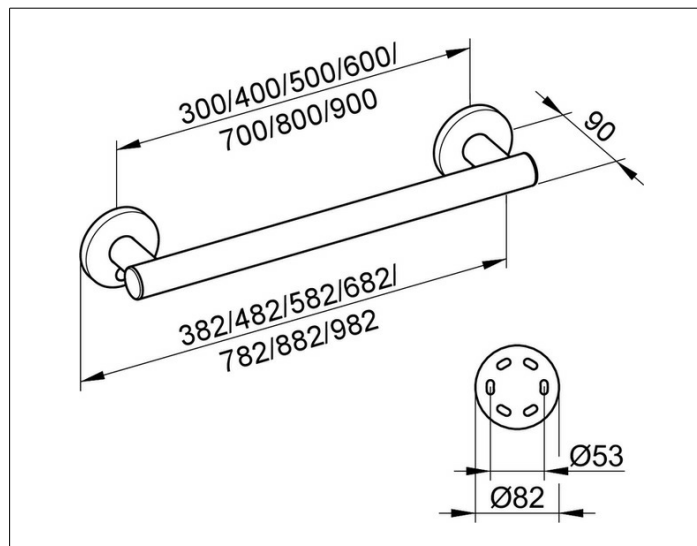

PRODUCT ATTRIBUTES

for horizontal or vertical installation

SURFACE

aluminium silver anodized (E6 EV1)/chrom

DIMENSION

882 mm

SPECIFICATIONS

KEUCO PLAN CARE grab rail
34901170800

Grab rail in aluminium silver anodized
in esthetic, practical and ergonomic Design
For horizontal or vertical Fitting up to 115 kg load capacity,
anti-static,
easy to clean

Pipe diameter 33 mm,
Rosette Diameter 82 mm
Base measurement 800 mm,
with a Total Width of 882 mm

Projection 90 mm,
Wall distance 57 mm

The Support handle will be at 6 places discretely mounted,
The Handle is TUEV-GS tested

Included in delivery:
mounting set 1 /Art. no. 34990 000100)
each 1 x per wall mounting set

Further mounting sets (depending on type of wall)
mounting set 4 (Art. no. 34990 000200), or
mounting set 7 (Art. no. 34993 000200)
Please order additionally
(each 1 x per wall mounting set)