

Plan Care

34912010900 Hand shower sliding rail

PRODUCT



DRAWING

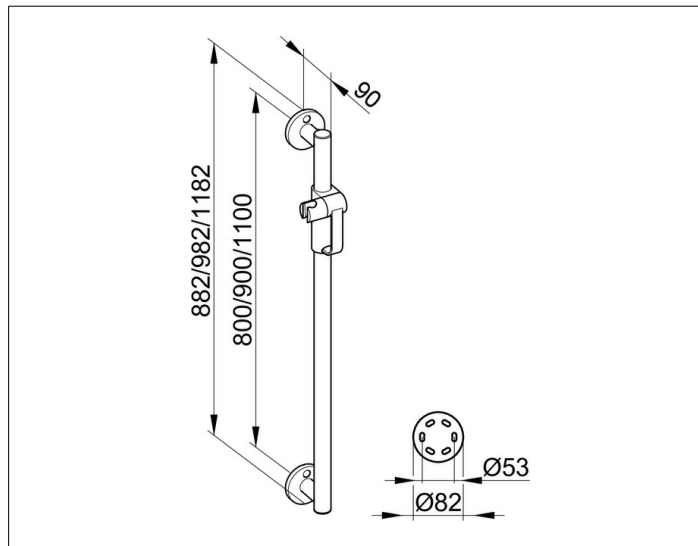

PRODUCT ATTRIBUTES

complete with hand-shower bracket,
mountable on the right or left side

SURFACE

chrome-plated

DIMENSION

982 mm

SPECIFICATIONS

KEUCO PLAN Hand shower sliding rail 34912010900
chrome-plated shower rail in aesthetic, functional
and ergonomic Design
complete with shower bracket
as supportgrip up to 115 kg loadable
antistatic
easy to clean
pipe diameter 33 mm
Rosette diameter 82 mm
Base measurement 900 mm
with a complete height of 982 mm
extendable 90 mm, wall distance 57 mm

Included in delivery:
2 x mounting set 1 (Art. no. 34990000100)

Further mounting sets
(depending on type of wall):
2 x mounting set 4 (Art. no. 34990 000200), or
2 x mounting set 7 (Art. no. 34993 000200)
Please order additionally!