

- DE** Montageanleitung
FR Instructions de montage
EN Assembly instructions
IT Istruzioni per Installazione
ES Instrucciones de montaje
NL Handleiding
DK Monteringsvejledning
PT Manual de Instalação
PL Instrukcja montażu
CS Montážní návod
SK Montážny návod
ZH 组装说明
RU Инструкция по монтажу
FI Asennusohje
SV Monteringsanvisning
LT Montavimo instrukcijos
HR Uputstva za instalaciju
RO Instrucțiuni de montare
EL Οδηγία συναρμολόγησης
SL Navodila za montažo
ET Paigaldusjuhend
LV Montāžas instrukcija
SR Uputstvo za montažu
NO Montasjeveiledning
BG Ръководство за монтаж
JP 施工説明書
UA Інструкція по збірці
AR تعليمات التجميع
TR Montaj kılavuzu
HU Szerelési útmutató
HE הוראות הרכבה

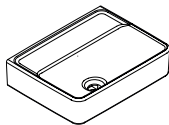

Xanua Q 450 / 340
60231450 / 61142450

Xanua Q 500 / 390
60234450 / 61145450

Xanua Q 550 / 370
60212450 / 61123450

Xanua Q 550 / 480
60237450 / 61148450

Xanua Q 600 / 370
60216450 / 61127450

Xanua Q 600 / 480
60242450 / 61151450

Xanua Q 650 / 390
60220450 / 61131450

Xanua Q 650 / 480
60247450 / 61154450

Xanua Q 700 / 480
60224450 / 61135450

Xanua Q 800 / 480
60228450 / 61139450

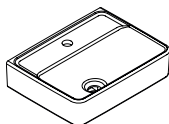

Xanua Q 450 / 340
60230450 / 61141450

Xanua Q 500 / 390
60233450 / 61144450

Xanua Q 550 / 370
60211450 / 61122450

Xanua Q 550 / 480
60236450 / 61147450

Xanua Q 600 / 370
60215450 / 61126450

Xanua Q 600 / 480
60241450 / 61150450

Xanua Q 650 / 390
60219450 / 61130450

Xanua Q 650 / 480
60246450 / 61153450

Xanua Q 700 / 480
60223450 / 61134450

Xanua Q 800 / 480
60227450 / 61138450

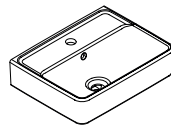

Xanua Q 450 / 340
6013045X / 6100745X

Xanua Q 500 / 390
6013145X / 6100845X

Xanua Q 550 / 370
60209450 / 61120450

Xanua Q 550 / 480
6013245X / 6100945X / 60238450

Xanua Q 600 / 370
60213450 / 61124450

Xanua Q 600 / 480
6013345X / 6101045X / 60243450

Xanua Q 650 / 390
60617450 / 61128450

Xanua Q 650 / 480
6013445X / 6101145X / 60252450

Xanua Q 700 / 480
60221450 / 60248450 / 61132450

Xanua Q 800 / 480
60225450 / 60250450 / 61136450

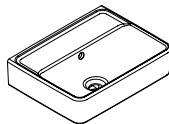

Xanua Q 450 / 340
60229450 / 61140450

Xanua Q 500 / 390
60232450 / 61143450

Xanua Q 550 / 370
60210450 / 61121450

Xanua Q 550 / 480
6023540 / 60239450 / 61146450

Xanua Q 600 / 370
60214450 / 61125450

Xanua Q 600 / 480
60240450 / 60244450 / 61149450

Xanua Q 650 / 390
60218450 / 61129450

Xanua Q 650 / 480
60245450 / 60254450 / 61152450

Xanua Q 700 / 480
60222450 / 60249450 / 61133450

Xanua Q 800 / 480
60226450 / 60251450 / 61137450

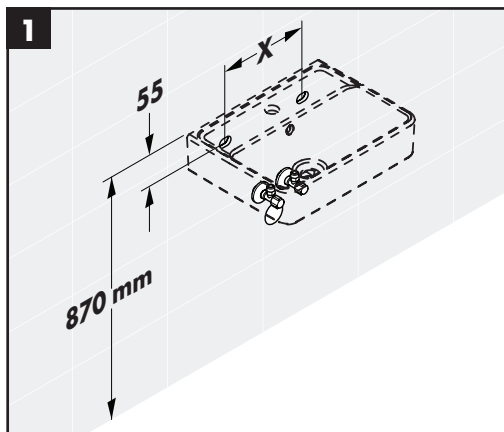

	X
Xanua Q 450 / 340	180 mm
Xanua Q 500 / 390	180 mm
Xanua Q 550 / 370	280 mm
Xanua Q 550 / 390	280 mm
Xanua Q 600 / 370	280 mm
Xanua Q 600 / 480	280 mm
Xanua Q 650 / 390	280 mm
Xanua Q 650 / 480	280 mm
Xanua Q 700 / 480	280 mm
Xanua Q 800 / 480	280 mm

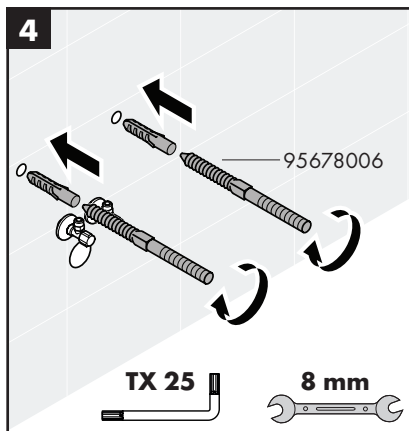
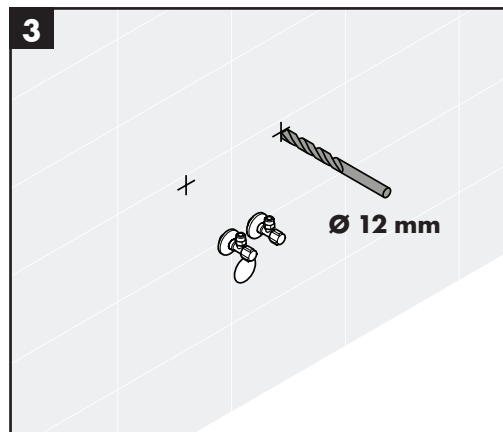
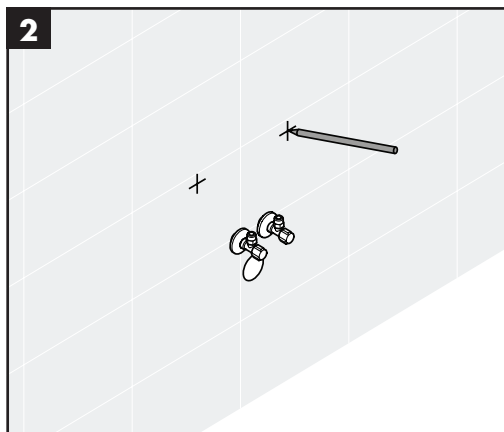

95678006

nicht im Lieferumfang enthalten / ne fait pas partie de la fourniture / order as an extra / non contenuto nel volume di forniture / no incluido en el suministro / behoort niet tot het leveringspakket / ikke med i leveringsomfang / não incluído no volume de fornecimento / Nie jest częścią dostawy / není součástí dodávky / nie je súčasťou dodávky / 不在供货范围内 / не включено в объем поставки! / ei kuulu toimitukseen / medfølger ej leveransen / nėra pridedama / Nije sadržano u isporuci! / nu este inclus în setul livrat / δεν περιλαμβάνεται στον παραδοτέο εξοπλισμό / Ni vključeno / ei sisaldu komplektis / komplektā netiek piegādāts / Nije sadržano u isporuci / ikke med i leveransen / не се съдържа в обема на доставка / 別手配部品 / в комплект поставки не входит / غير مدرج مع المحتويات المسلمة / Teslimat kapsamına dahil değildir / הזמנה של פריט אקסטרה /

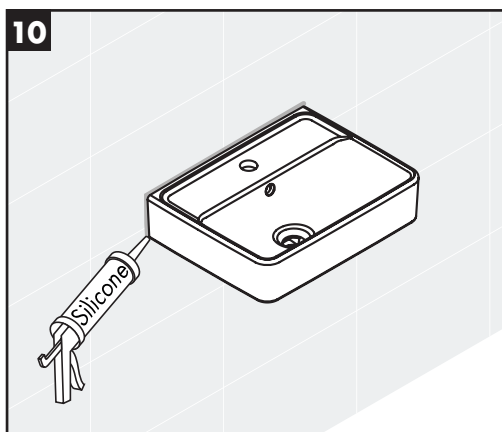
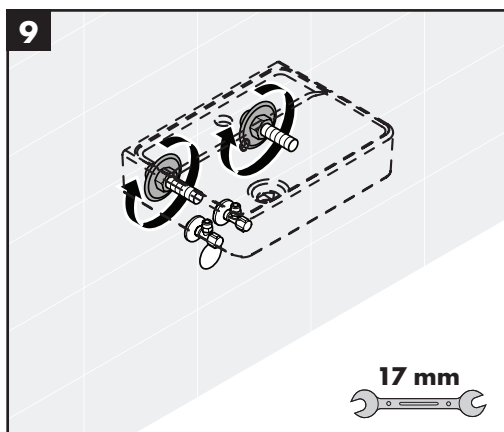
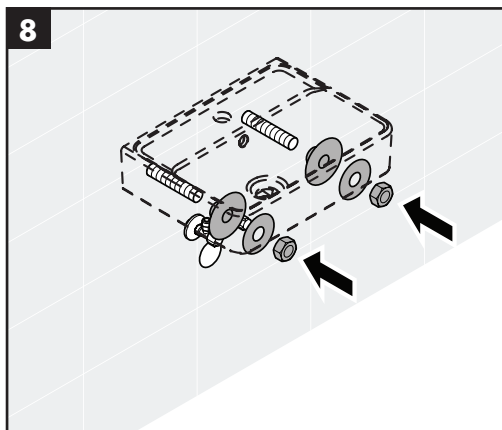
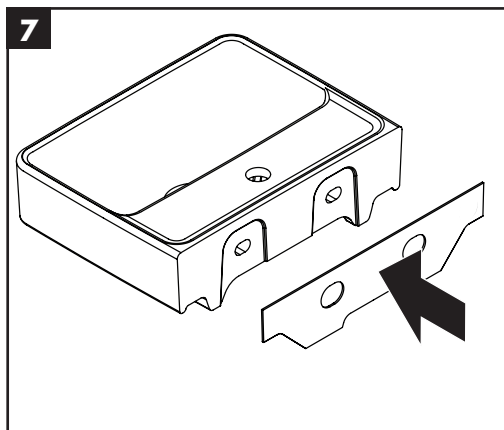
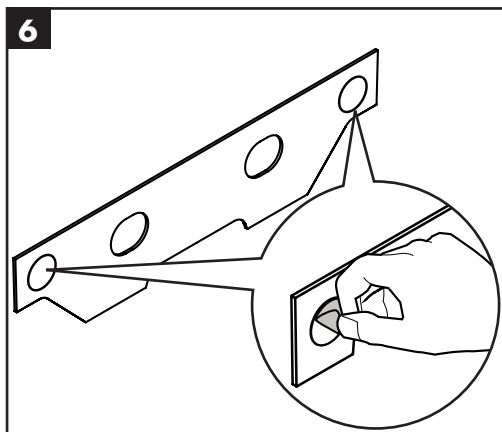
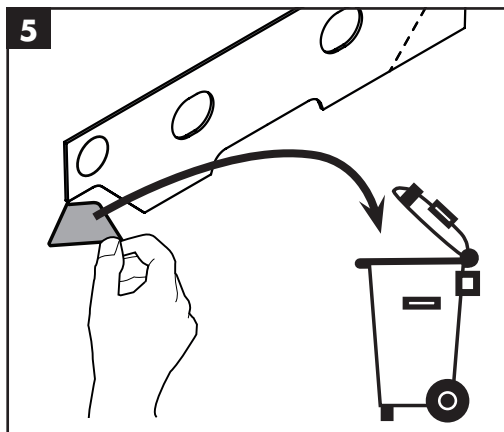



- DE** Die Zeichnungen enthalten alle notwendigen Maße (mm), die den üblichen Toleranzen unterliegen. Exakte Maße können nur am Produkt abgenommen werden.
- FR** Les schémas contiennent toutes les dimensions nécessaires (mm), qui sont soumises aux tolérances habituelles. Les dimensions exactes ne peuvent être prises que sur le produit.
- EN** The drawings contain all necessary dimensions (mm), which are subject to the usual tolerances. Exact dimensions can only be taken from the product.
- IT** I disegni contengono tutte le quote (mm) necessarie, che sono soggette alle comuni tolleranze. Le dimensioni esatte possono essere prese solo sul prodotto.
- ES** Los planos contienen todas las dimensiones necesarias (mm), que están sujetas a las tolerancias habituales. Las dimensiones exactas solamente se pueden tomar del producto.
- NL** De tekening bevatten alle noodzakelijke maten (mm) die onderhavig zijn aan de gebruikelijke toleranties. De nauwkeurige maten kunnen alleen aan het product worden genomen.
- DK** Tegningerne indeholder alle nødvendige mål (mm), som er omfattet af de sædvanlige tolerancer. Præcise mål findes kun på produktet.
- PT** Os desenhos contêm todas as dimensões necessárias (mm), as quais estão sujeitas às tolerâncias convencionais. As dimensões exatas só podem ser consultadas no produto.
- PL** Rysunki zawierają wszystkie niezbędne wymiary (mm), które podlegają zwykłym tolerancjom. Dokładne pomiary można wykonać tylko na produkcie.
- CS** Výkresy obsahují všechny požadované rozměry (mm), které podléhají běžným tolerancím. Přesné rozměry lze zjistit pouze přímo na produktu.
- SK** Výkresy obsahujú všetky potrebné rozmery (mm), na ktoré sa vzťahujú bežné tolerancie. Presné rozmery je možné zistiť len priamo na výrobku.
- ZH** 图纸包含所有必要的尺寸 (mm)。这些尺寸采用常见的公差。准确的测量只能在产品上测量。
- RU** На чертежах указаны все необходимые размеры (в мм), на которые распространяются обычные допуски. Точные размеры можно снять только с самого изделия.
- FI** Piirustukset sisältävät kaikki tarvittavat mitat (mm) tavallisilla toleransseilla. Tarkat mitat voi mitata tuotteelta.
- SV** Ritningarna visar alla nödvändiga mått (mm), som gäller för de vanliga toleranserna. Exakta mått kan endast tas från produkten.
- LT** Brėžiniuose pateikti visi būtini matmenys (mm), kuriems taikomi įprasti leidžiami nuokrypiai. Tikslūs matmenys pateikti tik ant gaminio.
- HR** Crteži sadrže sve potrebne dimenzije (mm), koje podliježu uobičajenim tolerancijama. Točne dimenzije mogu se preuzeti samo sa proizvoda.
- RO** Desenele conțin toate dimensiunile necesare (mm), care sunt supuse toleranțelor obișnuite. Măsurări exacte pot fi efectuate numai pe produs.
- EL** Τα σχέδια περιέχουν όλες τις απαραίτητες διαστάσεις (mm), οι οποίες υπόκεινται στις συνήθεις ανοχές. Οι ακριβείς μετρήσεις μπορούν να ληφθούν μόνο στο προϊόν.
- SL** Risbe vsebujejo vse potrebne mere (mm), za katere veljajo običajne tolerance. Točne mere je možno razbrati le z izdelka.
- ET** Joonised sisaldavad kõiki vajalikke mõõtmeid (mm), mille puhul kehtivad tavapärasel tolerantsid. Täpseid mõõte saab võtta ainult tootelt.
- LV** Zīmējumos ir norādīti visi nepieciešamie izmēri (mm), uz kuriem attiecas ierastās pielaides. Precīzus izmērus var redzēt tikai uz izstrādājuma.
- SR** Crteži sadrže sve potrebne dimenzije (mm), koje podležu uobičajenim tolerancijama. Tačne dimenzije mogu se preuzeti samo sa proizvoda.
- NO** Tegningene inneholder alle nødvendig mål (mm), som overholder vanlige toleranser. Nøyaktige mål kan kun hentes ved å måle produktet.
- BG** Чертежите съдържат всички необходими размери (mm), които са предмет на обичайните допуски. Точни размери могат да се вземат само от изделието.
- JP** 図面には必要な寸法 (mm) がすべて記載されていますが、これらは通常の公差に従います。正確な寸法は、製品からしか得られません。
- UA** Креслення містять усі потрібні розміри (мм), що знаходяться у межах звичайних допусків. Точні розміри можна виміряти лише на самому виробі.
- AR** تحتوي الرسومات على جميع الأبعاد الضرورية (مم) التي تخضع للتفاوتات المعتادة. لا يمكن أخذ القياسات الدقيقة إلا على المنتج.
- TR** Çizimler standart toleranslara tabi olan, gerekli tüm ölçüleri (mm) içermektedir. Tam ölçüler sadece üründen alınabilir.
- HU** A rajzok tartalmazzák az összes szükséges méretet (mm), amelyekre a szokásos tűréshatárok vonatkoznak. Pontos méreteket csak a termékről lehet venni.
- HE** התרשימים כוללים את כל המידות הנוצרות (מ"מ), הכפופות לגבולות החופש הרגילים. ניתן לבצע מדידה מדויקת רק במוצר.



Xanua Q 450 / 340

6013045X / 6100745X / 60231450 / 61142450 /
60229450 / 61140450 / 60230450 / 61141450

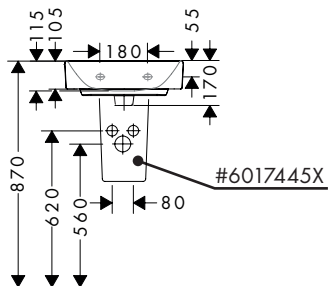
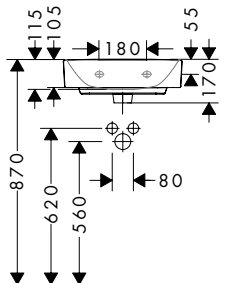
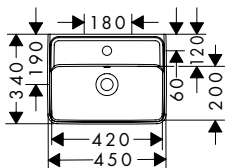

Xanua Q 500 / 390

6013145X / 6100845X / 60234450 / 61145450 /
60232450 / 61143450 / 60233450 / 61144450

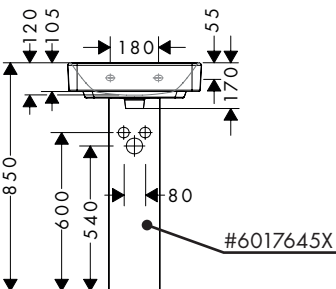
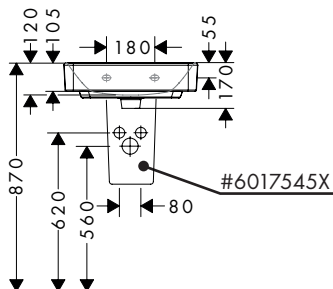
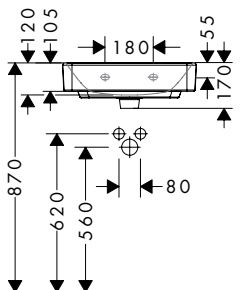
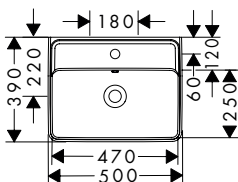



Xanua Q 550 / 370

60209450 / 61120450 / 60212450 / 61123450 /
60210450 / 61121450 / 60211450 / 61122450

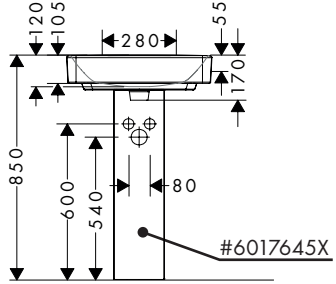
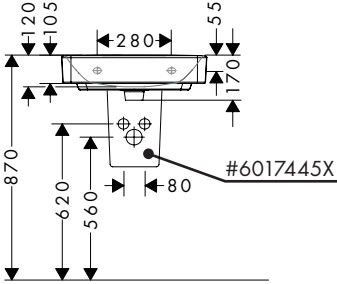
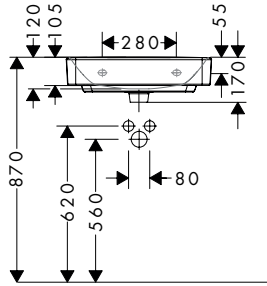
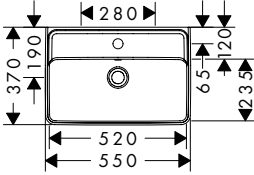

Xanua Q 550 / 480

6013245X / 6100945X / 60238450 / 60237450 /
61148450 / 60235450 / 60239450 / 61146450 /
60236450 / 61147450

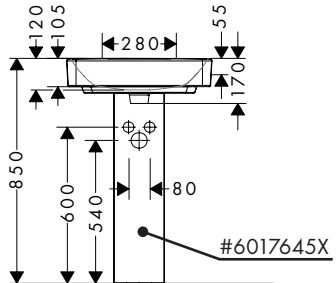
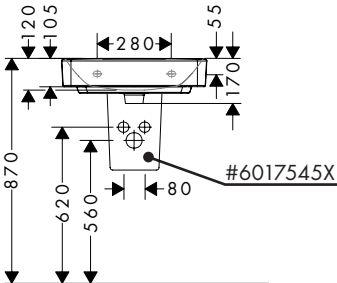
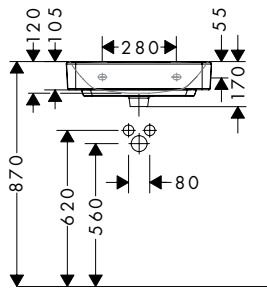
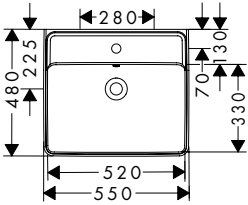



Xanua Q 600 / 370

60213450 / 60214450 / 60215450 / 60216450 /
61124450 / 61125450 / 61126450 / 61127450

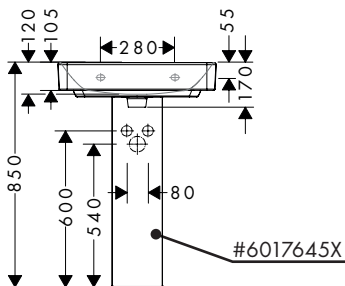
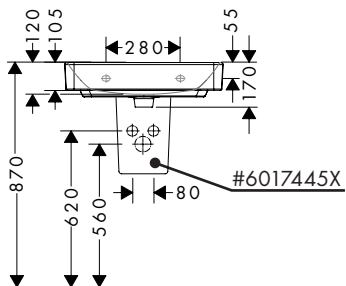
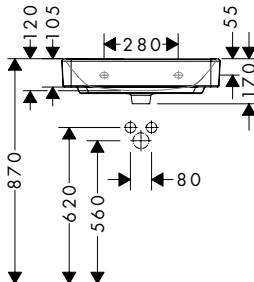
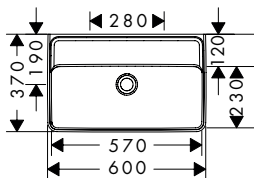

Xanua Q 600 / 480

6013345X / 6101045X / 60243450 / 6024245X /
61151450 / 60240450 / 60244450 / 61149450 /
60241450 / 61150450

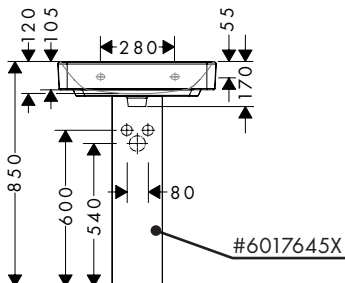
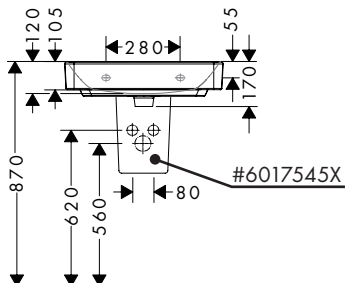
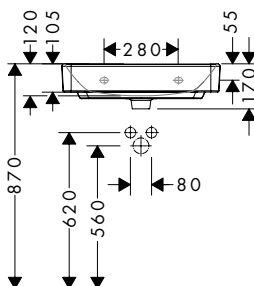
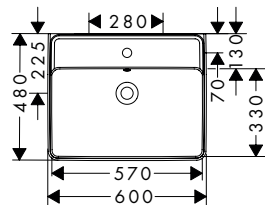



Xanua Q 650 / 390

60617450 / 61128450 / 60220450 / 61131450 /
60218450 / 61129450 / 60219450 / 61130450

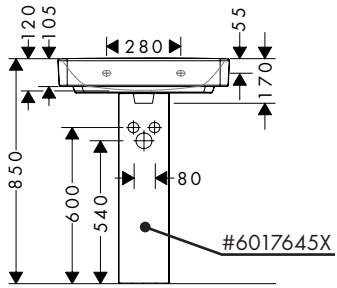
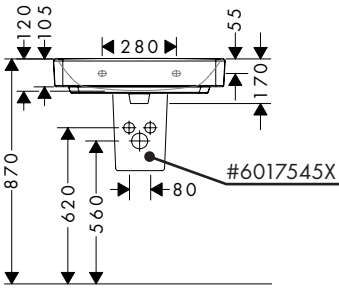
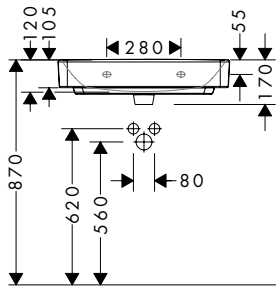
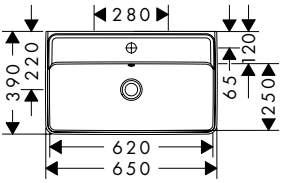

Xanua Q 650 / 480

6013445X / 6101145X / 60252450 / 60247450 /
61154450 / 60245450 / 60254450 / 61152450 /
60246450 / 61153450

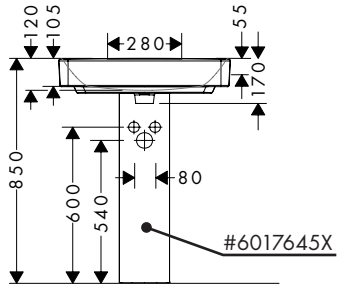
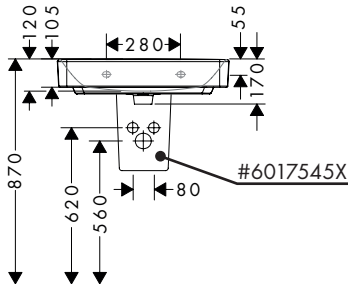
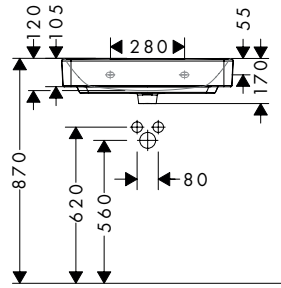
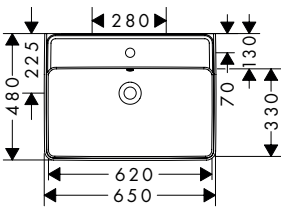



Xanua Q 700 / 480

60221450 / 60248450 / 61132450 / 60224450 /
61135450 / 60222450 / 60249450 / 61133450 /
60223450 / 61134450

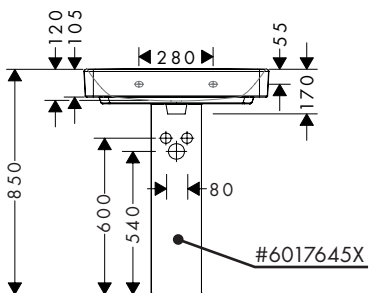
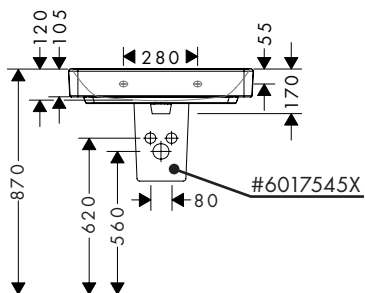
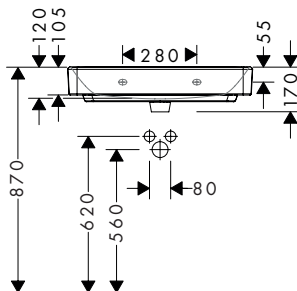
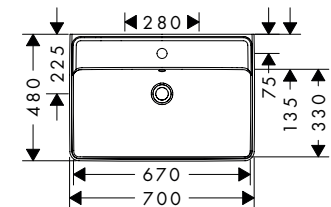

Xanua Q 800 / 480

60225450 / 60250450 / 61136450 / 60228450 /
61139450 / 60226450 / 60251450 / 61137450 /
60227450 / 61138450

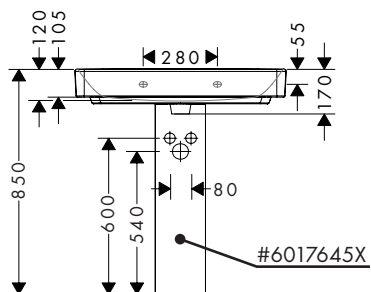
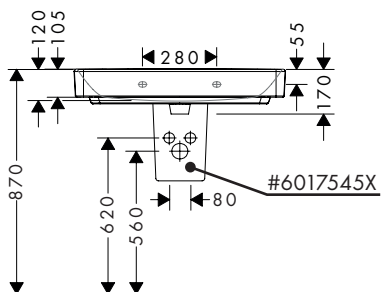
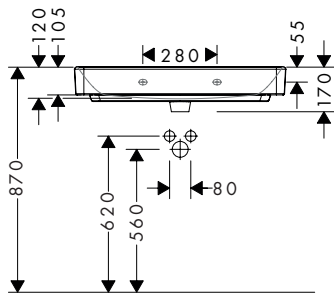
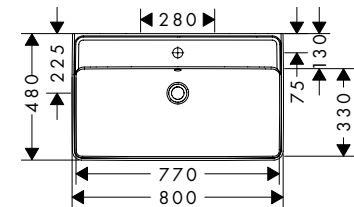



www.hansgrohe.com/cleaning-recommendation

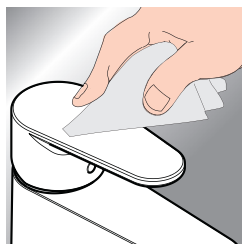

*www.hansgrohe.com/warranty



- DE** Reinigungsempfehlung / Garantie / Kontakt
FR Recommendation pour le nettoyage / Garanties / Contact
EN Cleaning recommendation / Warranty / Contact
IT Raccomandazione di pulizia / Garanzia / Contatto
ES Recomendaciones para la limpieza / Garantía / Contacto
NL Aanbevelingen inzake reiniging / Garantie / Contact
DK Rengøringsvejledning / Garanti / Kontakt
PT Recomendações de limpeza / Garantia / Contacto
PL Zalecenie dotyczący pielęgnacji / Gwarancja / Kontakt
CS Doporučení k čištění / Záruka / Kontakt
SK Odporúčania pre čistenie / Záruka / Kontakt
ZH 清洁指南 / 担保 / 接触
RU Рекомендации по очистке / Гарантия / Контакты
FI Puhdistussuositus / Takuu / Kosketus
SV Rengöringsrekommendationer / Garanti / Contacto
LT Valymo rekomendacijos / Garantija / Kontaktai

- HR** Preporuke za čišćenje / Garancija / Kontakt
RO Recomandări pentru curățare / Garanție / Contact
EL Σύσταση καθαρισμού / Εγγύηση / επαφή
SL Priporočilo za čiščenje / Garancija / Kontakt
ET Puhastussoovitused / Garantii / Kontakt
LV Tīrīšanas ieteikumi / Garantija / Kontakti
SR Preporuke za čišćenje / Garancija / Kontakt
NO Anbefaling for rengjøring / Garanti / Kontakt
BG Препоръка за почистване / Гаранция / Контакт
JP お手入れの方法 / 保証について / ご連絡先
UA Рекомендації з чищення / Гарантія / контакт
AR توصيات التنظيف / الضمان / اتصال
TR Temizleme önerisi / Garanti / Temas
 Garanti belgesi ve koşulları için www.hansgrohe.com.tr web sitesini ziyaret ederek; dijital garanti belgenize ulaşabilirsiniz.
HU Tisztítási tanácsok / Garancia / érintkezés
HE המלצות לניקוי / אחריות / איש קשר



Xanua Q 450 / 340

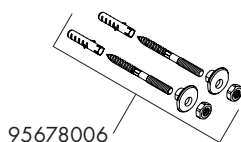
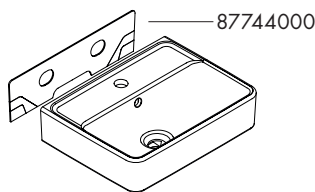

Xanua Q 500 / 390

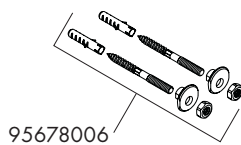
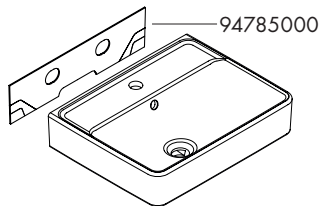

Xanua Q 550 / 370

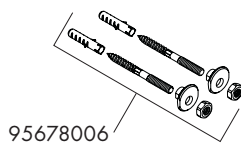
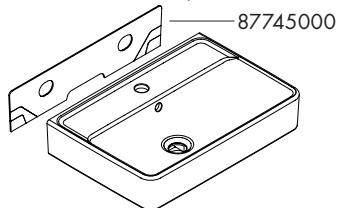

Xanua Q 550 / 480

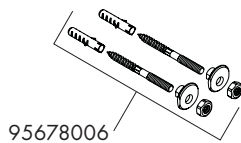
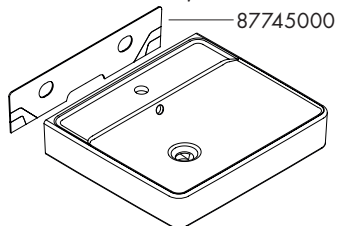

Xanua Q 600 / 370

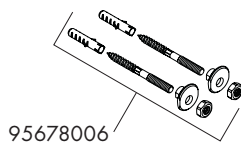
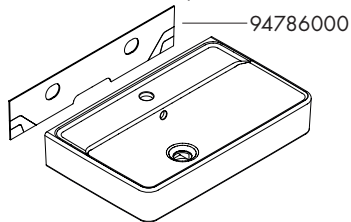

Xanua Q 600 / 480

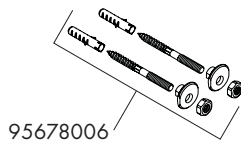
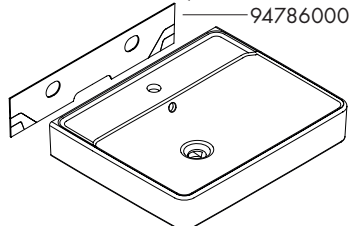



Xanua Q 650 / 390

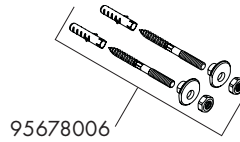
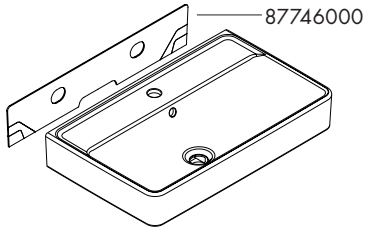

Xanua Q 650 / 480

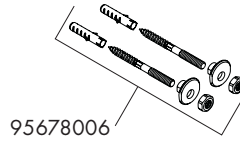
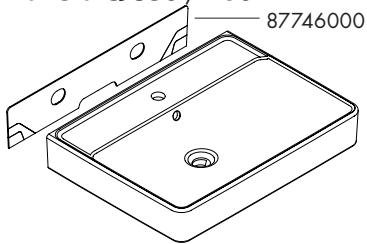

Xanua Q 700 / 480

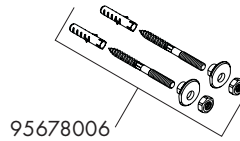
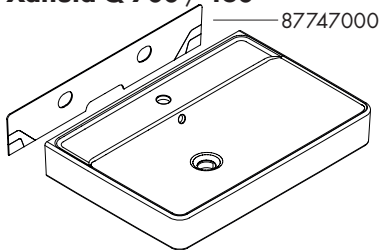

Xanua Q 800 / 480

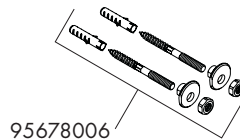
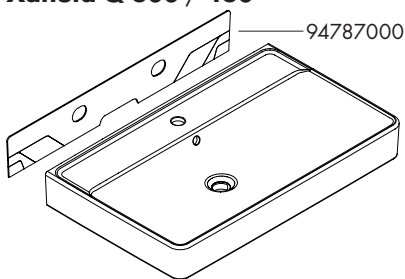

hansgrohe

Hansgrohe · Auestraße 5 · 9 · D-77761 Schiltach · Telefon +49 (0) 78 36/51-1282 · Telefax +49 (0) 7836/511440
E-Mail: info@hansgrohe.com · Internet: www.hansgrohe.com

10/2024
9.09205.03