

Plan Care

34901010400 Grab bar

PRODUCT



DRAWING

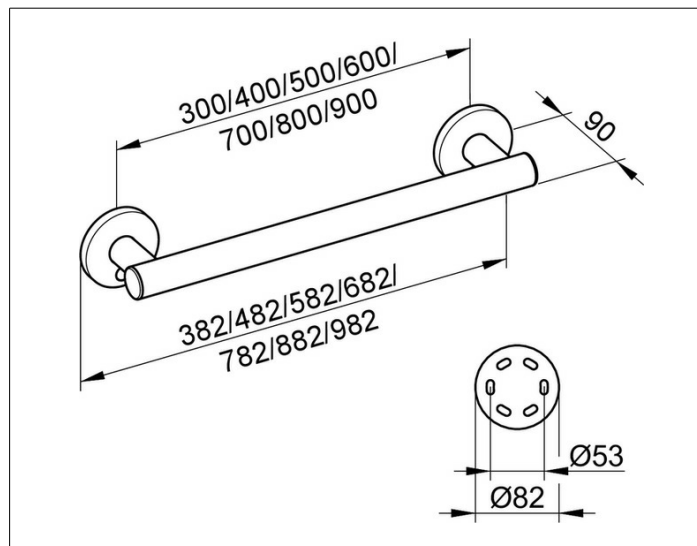

PRODUCT ATTRIBUTES

for horizontal or vertical installation

SURFACE

chrome-plated

DIMENSION

482 mm

SPECIFICATIONS

KEUCO PLAN CARE grab rail 34901010400

High shine chrome-plate grab rail

in esthetic, practical and ergonomic Design

For horizontal or vertical Fitting up to 115 kg load capacity,

anti-static,

easy to clean

Pipe diameter 33 mm,

Rosette Diameter 82 mm

Base measurement 400 mm,

with a Total Width of 482 mm

Projection 90 mm,

Wall distance 57 mm

The Support handle will be at 6 places discretely mounted,

The Handle is TUEV-GS tested

Included in delivery:

mounting set 1 /Art. no. 34990 000100)

each 1 x per wall mounting set

Further mounting sets (depending on type of wall)

mounting set 4 (Art. no. 34990 000200), or

mounting set 7 (Art. no. 34993 000200)

Please order additionally

(each 1 x per wall mounting set)