

IXMO

59516371201 Single lever basin mixer

PRODUCT



DRAWING

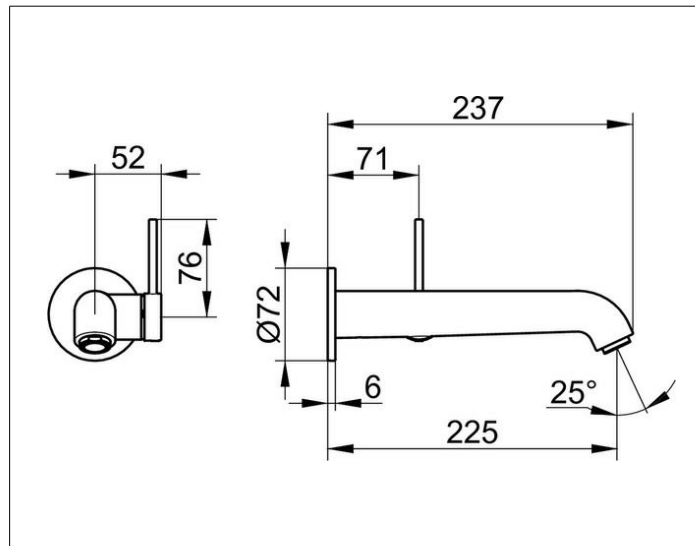

PRODUCT ATTRIBUTES

concealed, DN 15,
 Design IXMO Soft, with round decorative disc,
 mixing cartridge with ceramic sealing gaskets
 aerator SLIM SSR M 24x1, adjustable,
 flow rate limited to 7,6 l/min.
 in combination with rough part 59916 000075

SURFACE

black matt

DIMENSION

Ausladung 225 mm/IXMO Soft