

Shower and shower accessories

51688130400 Arm for head shower DN 15

PRODUCT



DRAWING

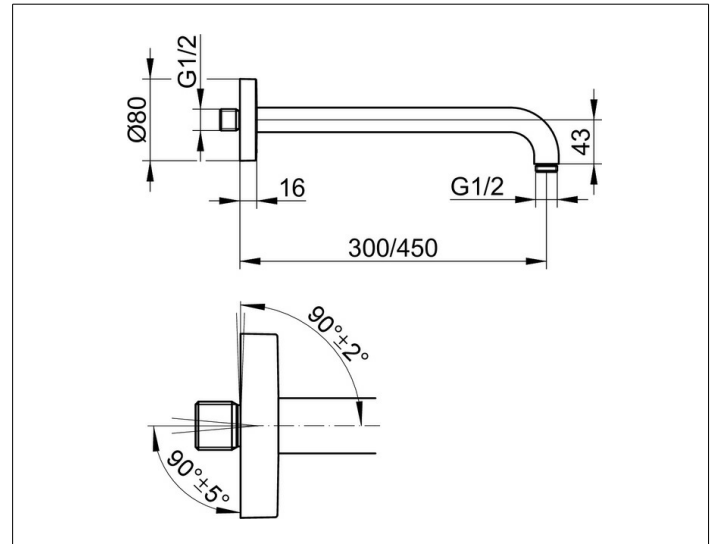

PRODUCT ATTRIBUTES

wall mounted G 1/2, with round decorative disc
 Opportunity of alignment on the wall ($90^\circ \pm 2^\circ$) and
 wall connection ($90^\circ \pm 5^\circ$)

SURFACE

brushed black chrome

DIMENSION

450 mm