

Plan Care

34901010800 Grab bar

PRODUCT



DRAWING

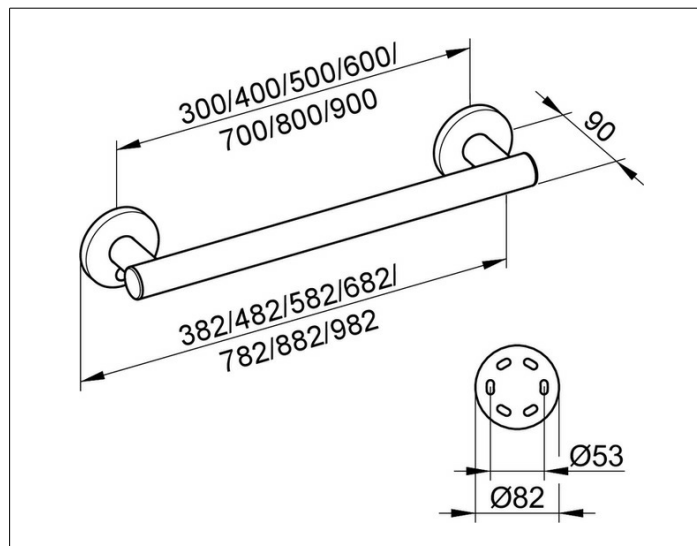

PRODUCT ATTRIBUTES

for horizontal or vertical installation

SURFACE

chrome-plated

DIMENSION

882 mm

SPECIFICATIONS

KEUCO PLAN CARE grab rail
34901010800

High shine chrome-plate grab rail
in esthetic, practical and ergonomic Design
For horizontal or vertical Fitting up to 115 kg load capacity,
anti-static,
easy to clean
Pipe diameter 33 mm,
Rosette Diameter 82 mm
Base measurement 800 mm,
with a Total Width of 882 mm
Projection 90 mm,
Wall distance 57 mm
The Support handle will be at 6 places discretely mounted,
The Handle is TUEV-GS tested

Included in delivery:
mounting set 1 /Art. no. 34990 000100)
each 1 x per wall mounting set

Further mounting sets (depending on type of wall)
mounting set 4 (Art. no. 34990 000200), or
mounting set 7 (Art. no. 34993 000200)
Please order additionally
(each 1 x per wall mounting set)