

Edition 400

51516010201 Single lever basin mixer

PRODUCT



DRAWING

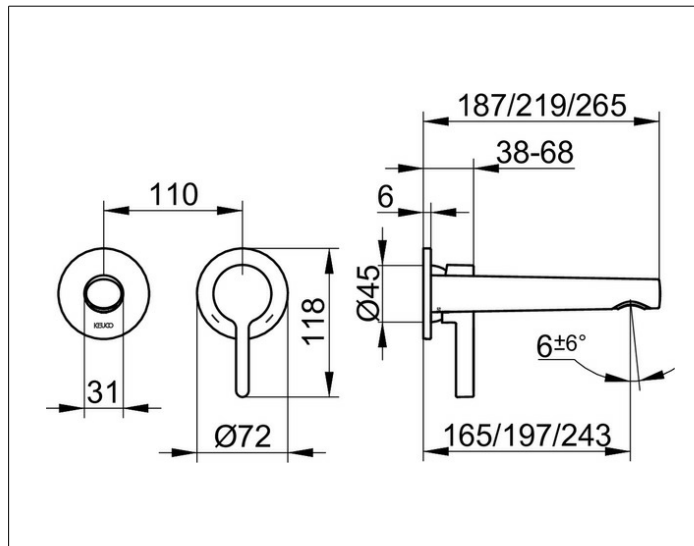

PRODUCT ATTRIBUTES

concealed, DN 15,
 mixing cartridge with ceramic sealing gaskets
 temperature controlled
 aerator SLIM SSR M 24x1, adjustable,
 flow rate limited to 7,6 l/min.
 in combination with rough part 59916 000070

SURFACE

chrome-plated

DIMENSION

Ausladung 165 mm

SPECIFICATIONS

KEUCO Edition 400 single lever basin mixer, 51516010201
 chrome-plated single lever basin mixer,
 sculptural design, concealed, DN15,
 high quality mixing cartridge with ceramic sealing gaskets,
 temperature controlled,
 rosette diameter 72 mm,
 diameter spout at the aerator 31 mm,
 aerator SLIM SSR M 24x1, adjustable $\pm 6^\circ$,
 total height control element 118 mm,
 width 182 mm, total depth 187 mm,
 flow rate limited to 7,6 l/min.

Note:
 suitable rough part Art.-No. 59916000070