

**Plan Care**

**34915016611 Rail system**

**PRODUCT**



**DRAWING**

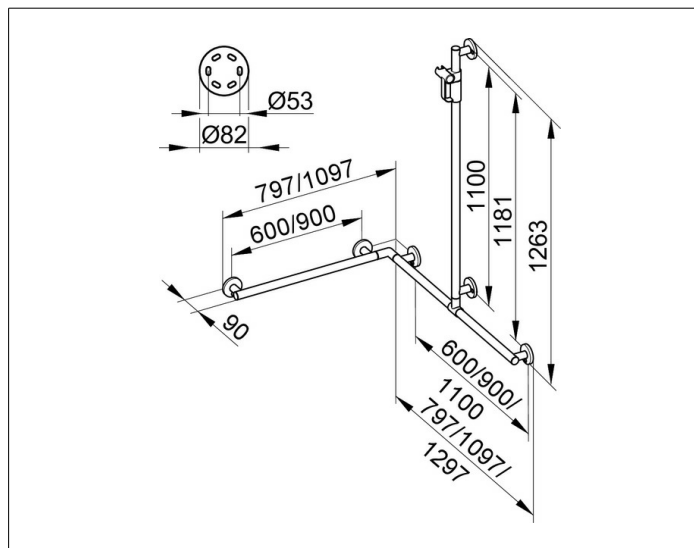

**PRODUCT ATTRIBUTES**

complete with hand-shower bracket,  
mountable on the right or left side, flexible positioning  
of sliding rail prior to final installation

**SURFACE**

chrome-plated

**DIMENSION**

797/797/1263 mm

**SPECIFICATIONS**

KEUCO PLAN CARE Shower handle,  
Angle / T-Shape and Shower rail  
34915016611  
high shine chrome-plated,  
complete with shower bracket,  
in esthetic, practical and ergonomic Design  
may be used on the left or right  
flexible positioning of sliding rail  
prior to final installation  
help up to 115 kg load capacity  
anti-static,  
easy to clean  
Base measurement 600/600/1100 mm  
Measurements: 797/797/1263 mm  
Pipe diameter 33 mm,  
6 Rosette Diameter 82 mm  
Extendable 90 mm,  
Wall distance 57 mm

May be combined with tip-up seat with backrest  
(Art. no. 34981) or spray guard (Art. no. 34940)

Included in delivery:  
6 x mounting set1 (Art. no. 34990000100)

Further mounting sets  
(depending on type of wall):  
6 x mounting set 4 (Art. no. 34990 000200), or  
6 x mounting set 7 (Art. no. 34993 000200)  
Please order additionally!